



InsulCurb8

Data Sheet

General Characteristics of the Insulated Roof Curb, InsulCurb8.

The insulated 8-inch-tall roof curbs are for EPDM, PVC and TPO roofs. The insulation improves energy efficiency and provides both a water and air barrier.

AVP uses Johns Manville's Foil Faced Polyisocyanurate Board Insulation. This provides a smooth surface resistant to absorption. As a result, adding any extra layer of protection. As moisture laden air moves through the roof curb to the vent or exhaust fan, there's no loose insulation to absorb moisture. Instead, the moisture will pass through the insulated roof curb and vent directly outside.

The Johns Manville insulation is double foiled to stop the build up of moisture. Instead, the foil repels water to prevent possible mold from forming.

AVP uses 1" thick board with an R-6 value for the RC-12 to RC-48 models. Fiberglass insulation for 1" is around R-3 value. The ridge board provides double the amount of insulation value available per inch of thickness.

The models RC-3 to RC-10 use a 1/2" Johns Manville's Foil Faced Polyiso Board Insulation. This 1/2" board provides an R-2.7 value.

Polyiso has the highest R-value per inch of any rigid board insulation. This insulation meets both CFC- and HCFC-free specification requirements.

AVP's curb mount flange vent lines are ready to install on the insulated roof curbs.

Product Applications of the Insulated Roof Curb, InsulCurb8.

An insulated roof curb is a component primarily used in construction and architecture to provide thermal insulation and moisture protection in the area where the roof meets the exterior walls of a building. It can be utilized in residential, commercial, industrial, agricultural, storage facilities, and refrigeration and freezing installations. The insulated roof curb can be employed in various environments to provide thermal insulation and moisture protection in the area where the roof meets the exterior walls of the building.

Warranty of the Insulated Roof Curb, InsulCurb8.

Manufacturer's Warranty: 1-Year



**Active
Ventilation
Products**

Specific Characteristics of the Insulated Roof Curb, InsulCurb8.

Item #	Manufacturing #	Height	Size	Outer Width	Inside Opening	Weight and Dimensions with Packaging	
						Lbs.	W,H,D In
USRCZ-001	RC-3-H8-Ins	8"	For a 3"Ø Vent or Fan	6"	5"	0.75	13,13,10
USRCZ-002	RC-4-H8-Ins	8"	For a 4"Ø Vent or Fan	7"	6"	1	14,14,10
USRCZ-003	RC-5-H8-Ins	8"	For a 5"Ø Vent or Fan	8"	7"	1	15,15,10
USRCZ-004	RC-6-H8-Ins	8"	For a 6"Ø Vent or Fan	9"	8"	1.5	16,16,10
USRCZ-005	RC-7-H8-Ins	8"	For a 7"Ø Vent or Fan	10"	9"	1.5	17,17,10



Specific Characteristics of the Insulated Roof Curb, InsulCurb8.

Item #	Manufacturing #	Height	Size	Outer Width	Inside Opening	Weight and Dimensions with Packaging	
						Lbs.	W,H,D In
USRCZ-006	RC-8-H8-Ins	8"	For a 8"Ø Vent or Fan	11"	10"	2	18,18,10
USRCZ-007	RC-9-H8-Ins	8"	For a 9"Ø Vent or Fan	12"	11"	2	19,19,10
USRCZ-008	RC-10-H8-Ins	8"	For a 10"Ø Vent or Fan	13"	12"	2.5	20,20,10
USRCZ-009	RC-12-H8-Ins	8"	For a 12"Ø Vent or Fan	15"	13"	2.5	22,22,10
USRCZ-010	RC-14-H8-Ins	8"	For a 14"Ø Vent or Fan	17"	15"	3	24,24,10
USRCZ-011	RC-16-H8-Ins	8"	For a 16"Ø Vent or Fan	19"	17"	3	26,26,10
USRCZ-012	RC-18-H8-Ins	8"	For a 18"Ø Vent or Fan	21"	19"	3.5	28,28,10
USRCZ-013	RC-20-H8-Ins	8"	For a 20"Ø Vent or Fan	23"	21"	3.5	30,30,10
USRCZ-014	RC-24-H8-Ins	8"	For a 24"Ø Vent or Fan	27"	25"	4	34,34,10
USRCZ-015	RC-30-H8-Ins	8"	For a 30"Ø Vent or Fan	33"	31"	4	40,40,10
USRCZ-016	RC-36-H8-Ins	8"	For a 36"Ø Vent or Fan	39"	37"	4.5	46,46,10
USRCZ-017	RC-42-H8-Ins	8"	For a 42"Ø Vent or Fan	45"	43"	4.5	52,52,10
USRCZ-018	RC-48-H8-Ins	8"	For a 48"Ø Vent or Fan	51"	49"	5	58,58,10

Dimensions (In.) of the Insulated Roof Curb, InsulCurb8.

Series		A	B	C	D	E	F	G	H	I	J
USRCZ-001	RC-3-H8-Ins	11"	11"	8"	6"	6"	6"	11"	6"	11"	5"
USRCZ-002	RC-4-H8-Ins	12"	12"	8"	7"	7"	7"	12"	7"	12"	6"
USRCZ-003	RC-5-H8-Ins	13"	13"	8"	8"	8"	8"	13"	8"	13"	7"
USRCZ-004	RC-6-H8-Ins	14"	14"	8"	9"	9"	9"	14"	9"	14"	8"
USRCZ-005	RC-7-H8-Ins	15"	15"	8"	10"	10"	10"	15"	10"	15"	9"
USRCZ-006	RC-8-H8-Ins	16"	16"	8"	11"	11"	11"	16"	11"	16"	10"
USRCZ-007	RC-9-H8-Ins	17"	17"	8"	12"	12"	12"	17"	12"	17"	11"
USRCZ-008	RC-10-H8-Ins	18"	18"	8"	13"	13"	13"	18"	13"	18"	12"
USRCZ-009	RC-12-H8-Ins	20"	20"	8"	15"	15"	15"	20"	15"	20"	13"
USRCZ-010	RC-14-H8-Ins	22"	22"	8"	17"	17"	17"	22"	17"	22"	15"
USRCZ-011	RC-16-H8-Ins	24"	24"	8"	19"	19"	19"	24"	19"	24"	17"
USRCZ-012	RC-18-H8-Ins	26"	26"	8"	21"	21"	21"	26"	21"	26"	19"
USRCZ-013	RC-20-H8-Ins	28"	28"	8"	23"	23"	23"	28"	23"	28"	21"
USRCZ-014	RC-24-H8-Ins	32"	32"	8"	27"	27"	27"	32"	27"	32"	25"
USRCZ-015	RC-30-H8-Ins	38"	38"	8"	33"	33"	33"	38"	33"	38"	31"
USRCZ-016	RC-36-H8-Ins	44"	44"	8"	39"	39"	39"	44"	39"	44"	37"
USRCZ-017	RC-42-H8-Ins	50"	50"	8"	45"	45"	45"	50"	45"	50"	43"
USRCZ-018	RC-48-H8-Ins	56"	56"	8"	51"	51"	51"	56"	51"	56"	49"



Outer Width

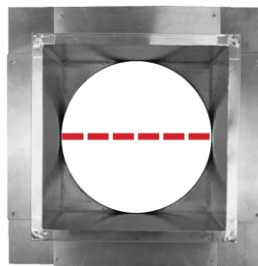

Inside Opening

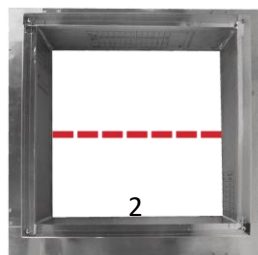

2

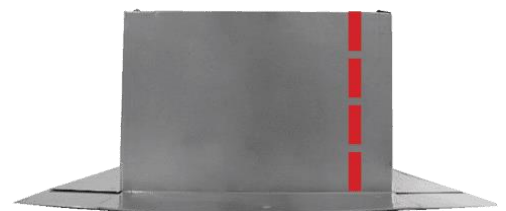

Height

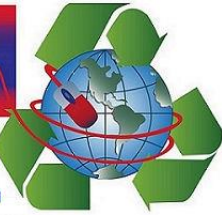

InsulCurb8

Data Sheet

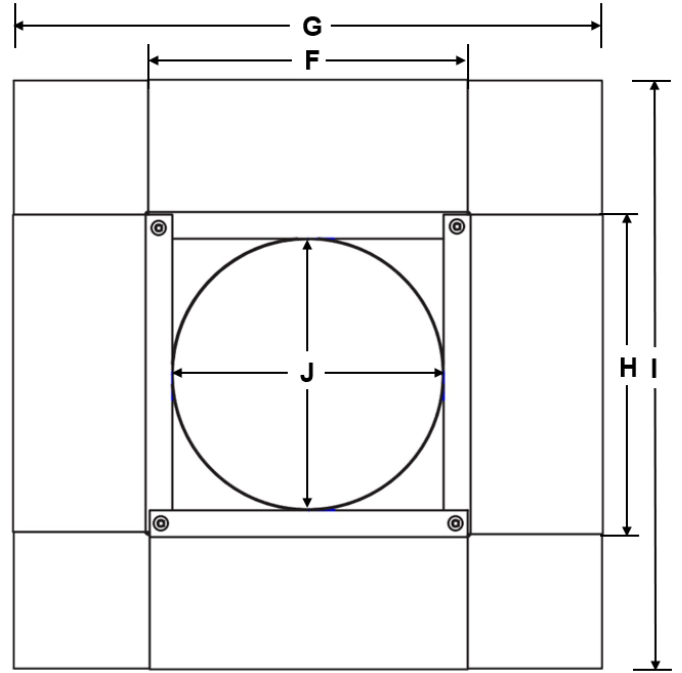
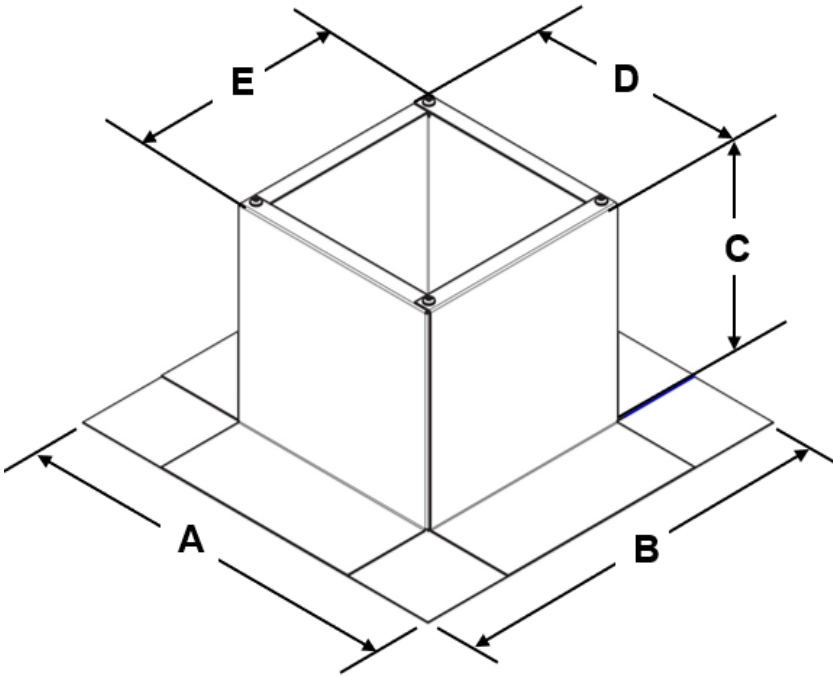

Gallery Image of the Insulated Roof Curb, InsulCurb8.

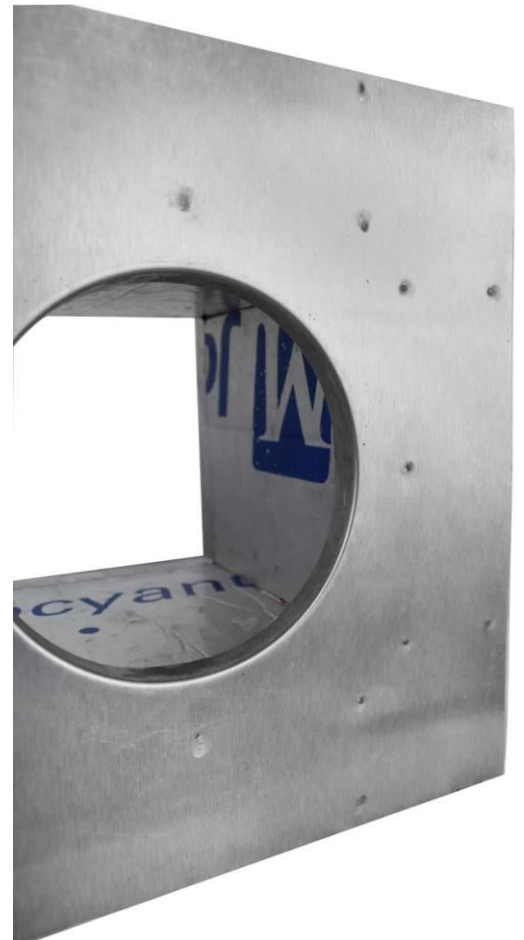
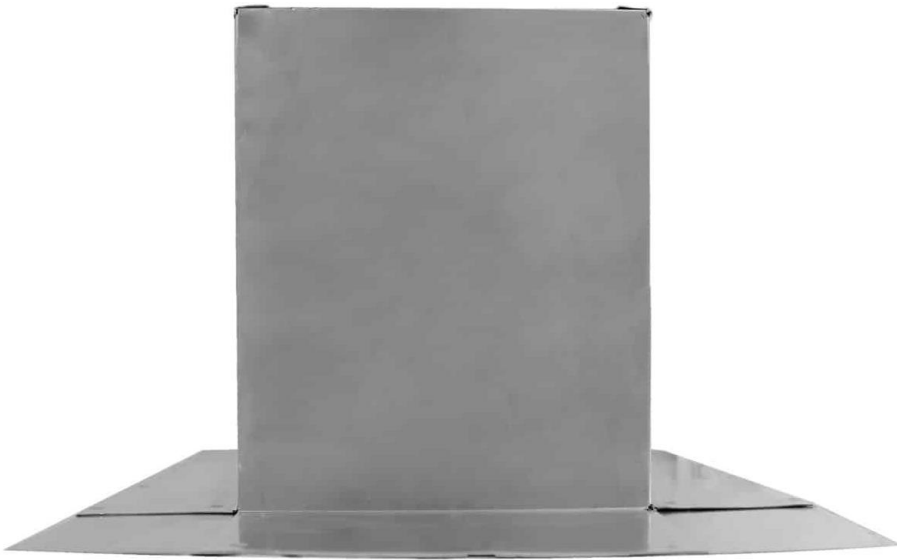

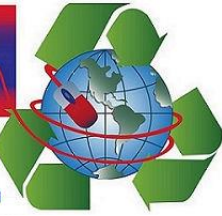

InsulCurb8

Data Sheet

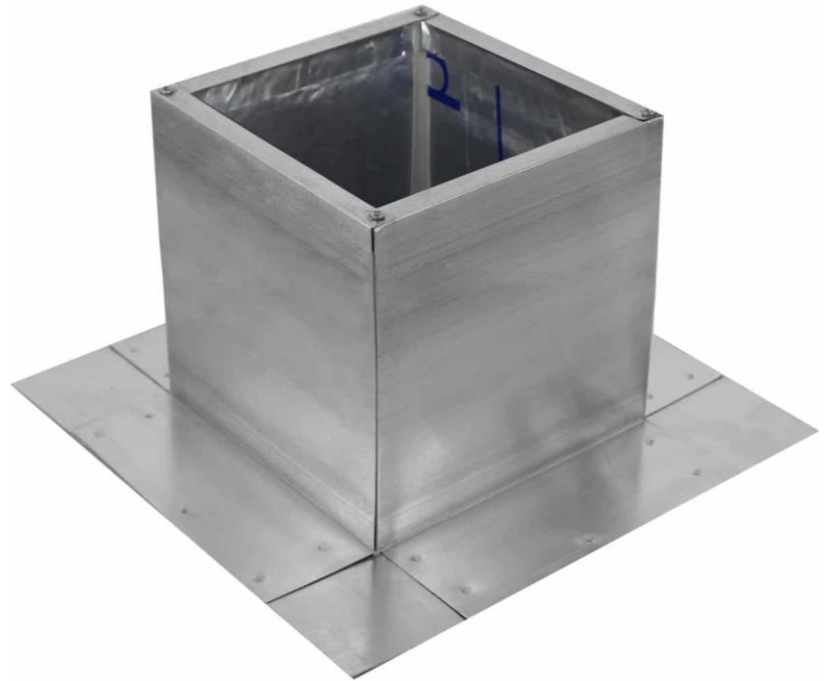
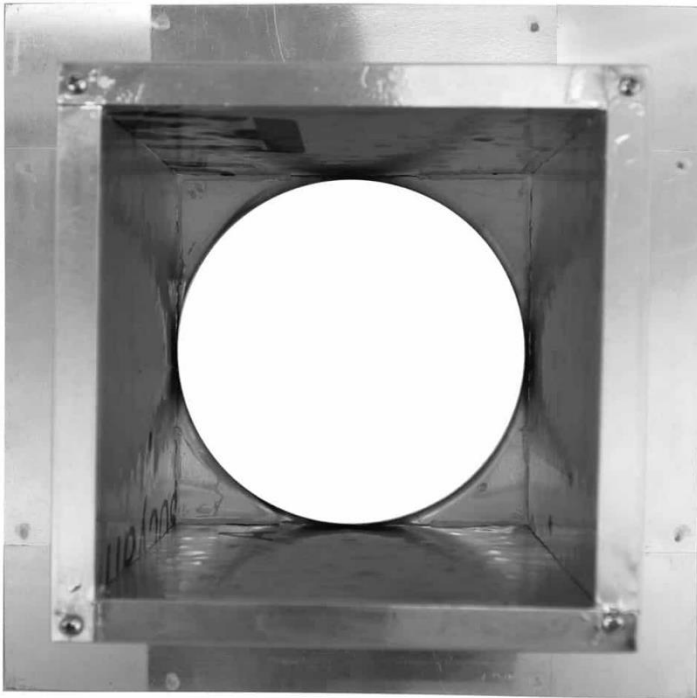
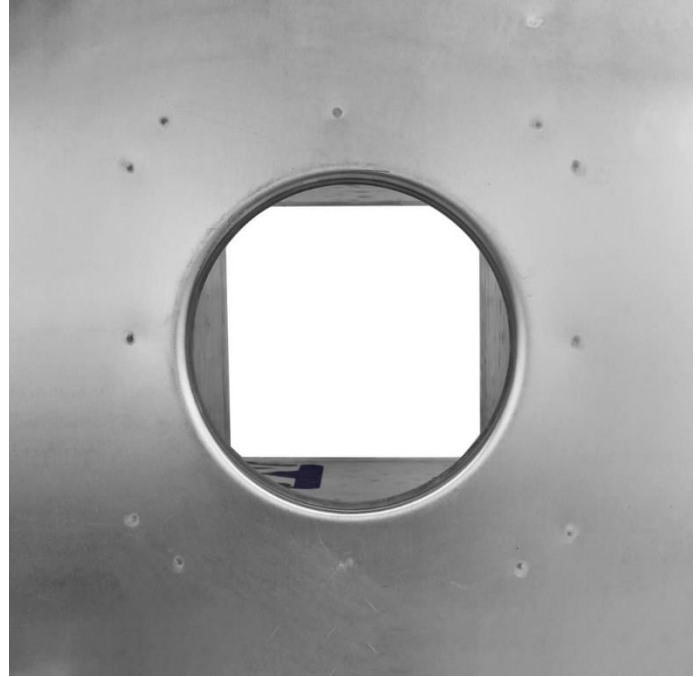
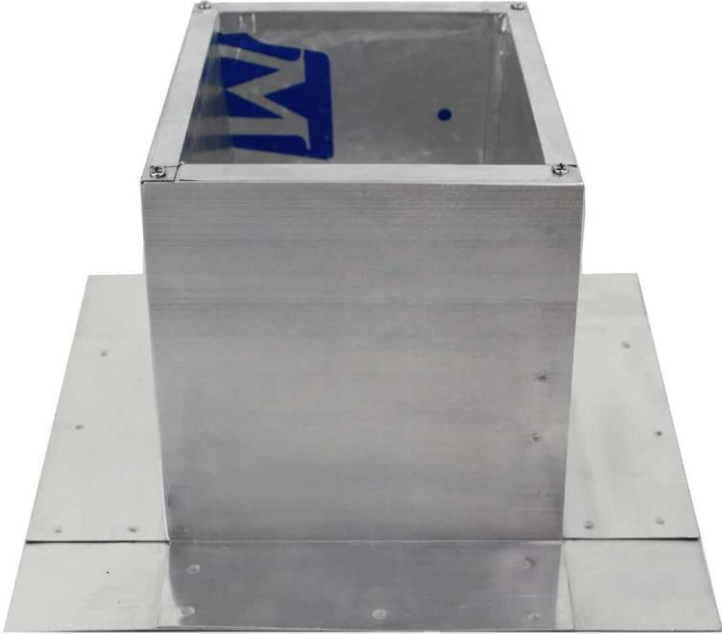



InsulCurb8

Data Sheet

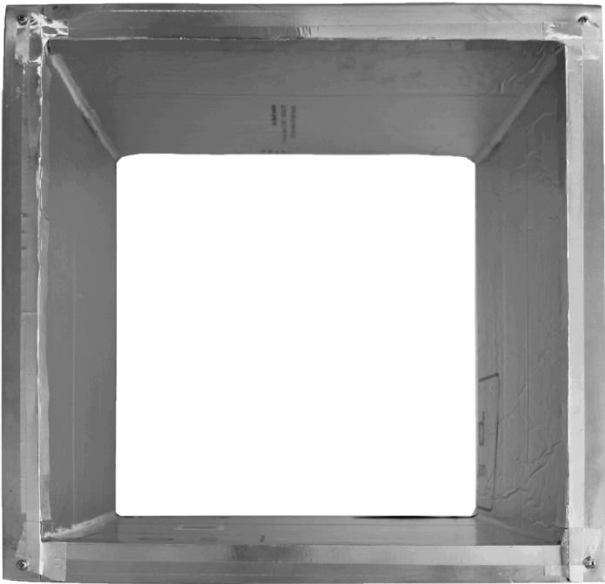
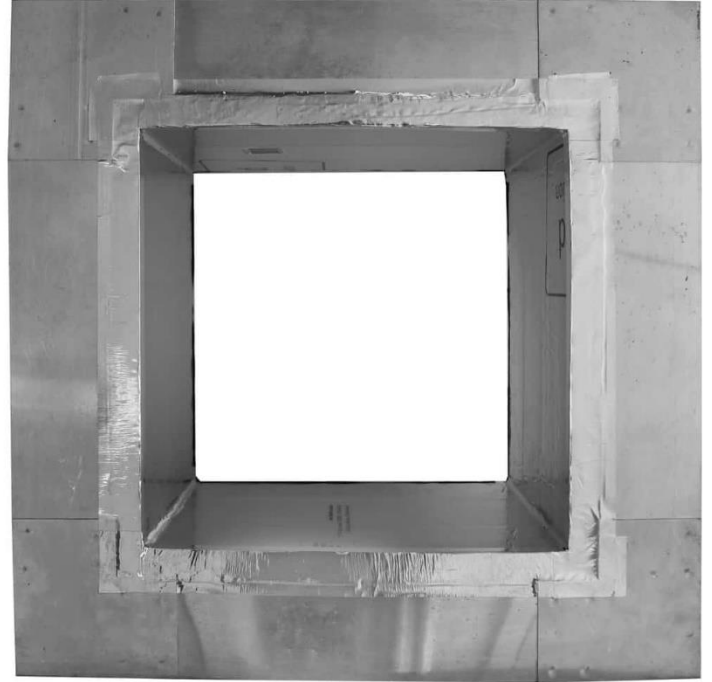
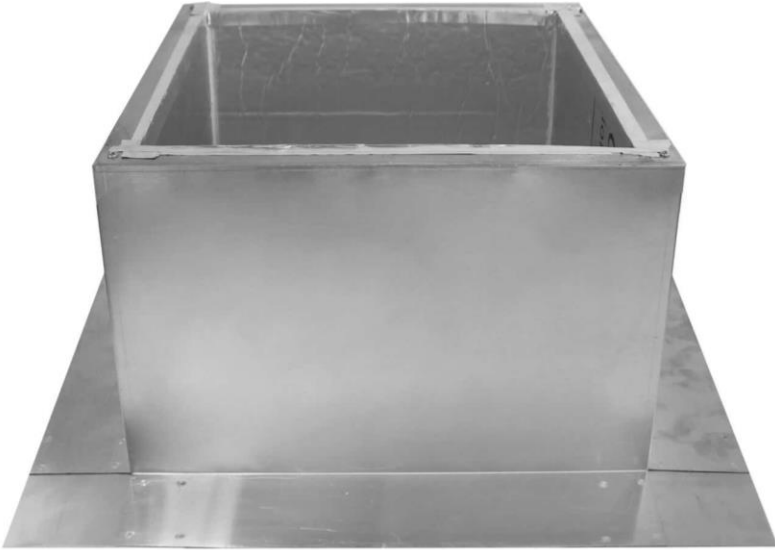



InsulCurb8

Data Sheet



ID	Author	Description Error	Description Update	Supervisor Name
V1	Marcela Roldán	New Specification Sheet	New Specification Sheet	J.L.